

YAMAHA

RX-495RDS/395/395RDS

Natural Sound Stereo Receiver

Récepteur stéréo "Son Naturel"

Natural Sound Stereoreceiver

Natural Sound Stereoreceiver

Sintonizzatore stereo a suono naturale

Receptor estéreo de Sonido Natural

Natural Sound Stereo Ontvanger

**OWNER'S MANUAL
MODE D'EMPLOI
BEDIENUNGSANLEITUNG
BRUKSANVISNING
MANUALE DI ISTRUZIONI
MANUAL DE INSTRUCCIONES
GEBRUIKSAANWIJZING**

SUPPLIED ACCESSORIES
ACCESSOIRES FOURNIS
MITGELIEFERTE ZUBEHÖRTEILE
MEDFÖLJANDE TILLBEHÖR
ACCESSORI IN DOTAZIONE
ACCESORIOS INCLUIDOS
BIJGELEVERDE ACCESSOIRES

- After unpacking, check that the following parts are included.
- Après le déballage, vérifier que les pièces suivantes sont incluses.
- Nach dem Auspacken überprüfen, ob die folgenden Teile vorhanden sind.
- Kontrollera efter det apparaten packats upp att följande delar finns med.
- Verificare che tutte le parti seguenti siano contenute nell'imbballaggio dell'apparecchio.
- Desembale el aparato y verificar que los siguientes accesorios están en la caja.
- Controleer na het uitpakken of de volgende onderdelen voorhanden zijn.

- Indoor FM Antenna
- Antenne FM intérieure
- UKW-Innenantenne
- FM inomhusantenn
- Antenna FM per interni
- Antena FM interior
- FM Binnenantenne

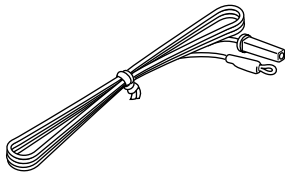

- Remote Control Transmitter
- Emetteur de télécommande
- Fernbedienungsgeber
- Fjärrkontrollsändare
- Telecomando
- Transmisor del control remoto
- Afstandbediening

RX-495RDS

RX-395, RX-395RDS



- AM Loop Antenna
- Cadre-Antenne AM
- MW-Rahmenantenne
- AM ramantenn
- Antenna AM ad anello
- Antena de cuadro de AM
- AM Lusantenne

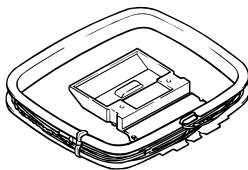

- Batteries (size AA, R6, UM-3)
- Piles (taille AA, R6, UM-3)
- Batterien (Größe AA, R6, UM-3)
- Batterier (storlek AA, R6, UM-3)
- Batterie (dimensioni AA, R6, UM-3)
- Pilas (tamaño AA, R6, UM-3)
- Batterijen (maat AA, R6, UM-3)

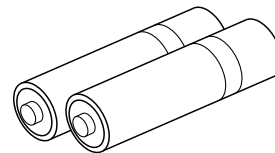

This product complies with the radio frequency interference requirements of the Council Directive 82/499/EEC and/or 87/308/EEC.

Cet appareil est conforme aux prescriptions de la directive communautaire 87/308/CEE.

Diese Geräte entsprechen der EG-Richtlinie 82/499/EWG und/oder 87/308/EWG.

Detta apparat överholder det gældende EF-direktiv vedrørende radiostøj.

Questo apparecchio è conforme al D.M.13 aprile 1989 (Direttiva CEE/87/308) sulla soppressione dei radiodisturbi.

Este producto está de acuerdo con los requisitos sobre interferencias de radio frecuencia fijados por el Consejo Directivo 87/308 CEE.

Dit product voldoet aan de EEG normen betreffende radio-frekventie storingen 82/499/EEG en/of 87/308/EEG.

FEATURES

- **RX-495RDS**
70W + 70W (8Ω) RMS Output
Power, 0.04% THD, 20–20,000 Hz
- **RX-395, RX-395RDS**
45W + 45W (8Ω) RMS Output
Power, 0.04% THD, 20–20,000 Hz
- High Dynamic Power, Low Impedance
Drive Capability
- Continuously Variable Loudness Control
- 40-Station Random Access Preset Tuning
- Automatic Preset Tuning
- Preset Station Shifting Capability (Preset
Editing)
- IF Count Direct PLL Synthesizer Tuning
System
- SLEEP Timer
- Remote Control Capability
- **RX-495RDS and RX-395RDS only**
Multi-Functions for RDS Broadcast
Reception
- **RX-495RDS only**
PURE DIRECT Switch to Reproduce the
Purest Source Sound

CONTENTS

Supplied Accessories	2	Receiving RDS Stations	
Caution	4	RX-495RDS and RX-395RDS only	22
Controls and Their Functions	5	Notes about the Remote Control Transmitter	
Connections	10	27
Basic Operations	14	Troubleshooting	28
Tuning Operations	17	Specifications	29
Preset Tuning	18		

CAUTION : READ THIS BEFORE OPERATING YOUR UNIT.

1. To assure the finest performance, please read this manual carefully. Keep it in a safe place for future reference.
2. Install this unit in a cool, dry, clean place – away from windows, heat sources, sources of excessive vibration, dust, moisture and cold. Avoid sources of humming (transformers, motors). To prevent fire or electrical shock, do not expose the unit to rain or water.
3. Never open the cabinet. If something drops into the set, contact your dealer.
4. Do not use force on switches, controls or connection wires. When moving the unit, first disconnect the power plug and the wires connected to other equipment. Never pull the wires themselves.
5. The openings on the cabinet assure proper ventilation of the unit. If these openings are obstructed, the temperature inside the cabinet will rise rapidly. Therefore, avoid placing objects against these openings, and install the unit in well-ventilated condition. Make sure to allow a space of at least 10 cm behind, on the both sides and above the top panel of the unit. Otherwise it may not only damage the unit, but also cause fire.
6. Always set the VOLUME control to “– ∞” before starting the audio source play. Increase the volume gradually to an appropriate level after playback has been started.
7. Do not attempt to clean the unit with chemical solvents; this might damage the finish. Use a clean, dry cloth.
8. Be sure to read the “TROUBLESHOOTING” section regarding common operating errors before concluding that the unit is faulty.
9. When not planning to use this unit for long periods of time (ie., vacation, etc.), disconnect the AC power plug from the wall outlet.
10. To prevent lightning damage, disconnect the AC power plug and disconnect the antenna cable when there is an electrical storm.
11. Grounding or polarization – Precautions should be taken so that the grounding or polarization of an appliance is not defeated.
12. AC outlet
Do not connect audio equipment to the AC outlet on the rear panel if that equipment requires more power than the outlet is rated to provide.

For U.K. customers

If the socket outlets in the home are not suitable for the plug supplied with this appliance, it should be cut off and an appropriate 3 pin plug fitted. For details, refer to the instructions described below.

Note: The plug severed from the mains lead must be destroyed, as a plug with bared flexible cord is hazardous if engaged in a live socket outlet.

Special Instructions for U.K. Model

IMPORTANT

THE WIRES IN THE MAINS LEAD ARE COLOURED IN ACCORDANCE WITH THE FOLLOWING CODE:

Blue: NEUTRAL

Brown: LIVE

As the colours of the wires in the main lead of this apparatus may not correspond with the coloured markings identifying the terminals in your plug, proceed as follows:

The wire which is coloured BLUE must be connected to the terminal which is marked with the letter N or coloured BLACK. The wire which is coloured BROWN must be connected to the terminal which is marked with the letter L or coloured RED. Make sure that neither core is connected to the earth terminal of the three pin plug.

The apparatus is not disconnected from the AC power source as long as it is connected to the wall outlet, even if the apparatus itself is turned off.

IMPORTANT

Please record the serial number of this unit in the space below.

Serial No.:

The serial number is located on the rear of the unit. Retain this Owner's Manual in a safe place for future reference.

WARNING

TO REDUCE THE RISK OF FIRE OR ELECTRIC SHOCK, DO NOT EXPOSE THIS UNIT TO RAIN OR MOISTURE.

REMOTE CONTROL TRANSMITTER

The remote control transmitter provided with this unit is designed to control all the most commonly used functions of the unit. If the CD player and tape deck connected to this unit are YAMAHA components designed for remote control compatibility, then this remote control transmitter will also control various functions of each component.

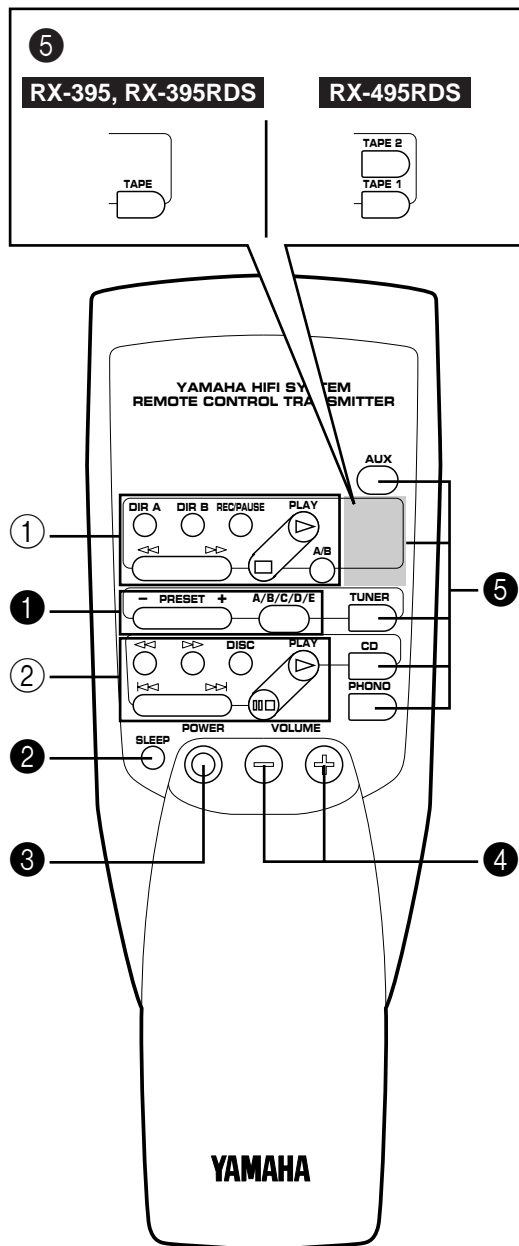

For Control of This Unit

① Tuner keys

Controls tuner.

+: Selects higher preset station number.

-: Selects lower preset station number.

A/B/C/D/E: Selects the group (A – E) of preset station numbers.

② SLEEP timer key

The power to this unit is automatically turned off one hour after this key is pressed (so that “SLEEP” lights up on the display).

③ POWER key

Turns the power on/off.

* While the power is on, pressing the **POWER** key on the remote control transmitter switches the unit from the power-on mode to the standby mode, and vice versa. (In the standby mode, the power indicator on the front panel is half illuminated.)

④ VOLUME +/- keys

Turns the volume level up/down.

⑤ Input selector keys

Selects input source.

For Other Component Control

Identify the remote control transmitter keys with your component's keys. If these keys are identical, their functions will be the same. On each key function, refer to the corresponding instruction on your component's manual.

① Tape deck keys

Controls tape deck.

* **DIR A, B** and **A/B** are applicable only to double cassette tape deck.

* For a single cassette deck with automatic reverse function, pressing **DIR A** will reverse the direction of tape running.

② CD player keys

Controls compact disc player.

* **DISC** is applicable only to compact disc changer.

FRONT PANEL

RX-495RDS

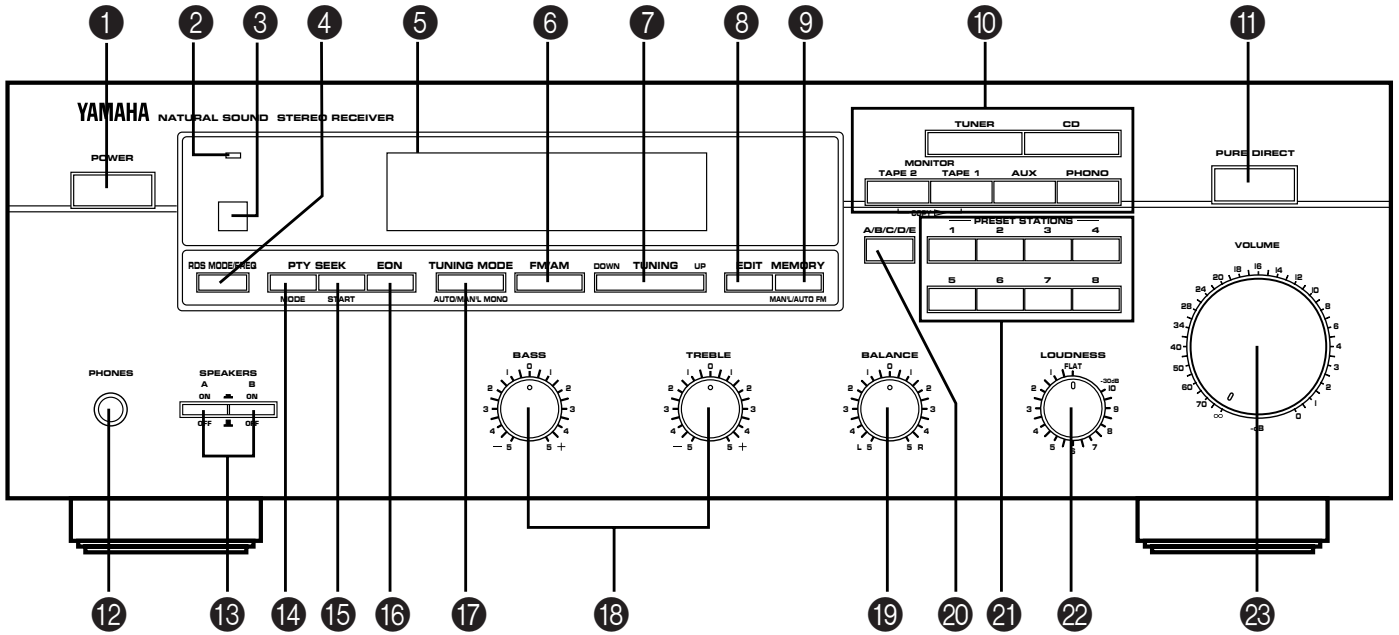

RX-395, RX-395RDS

■ : RX-395RDS only

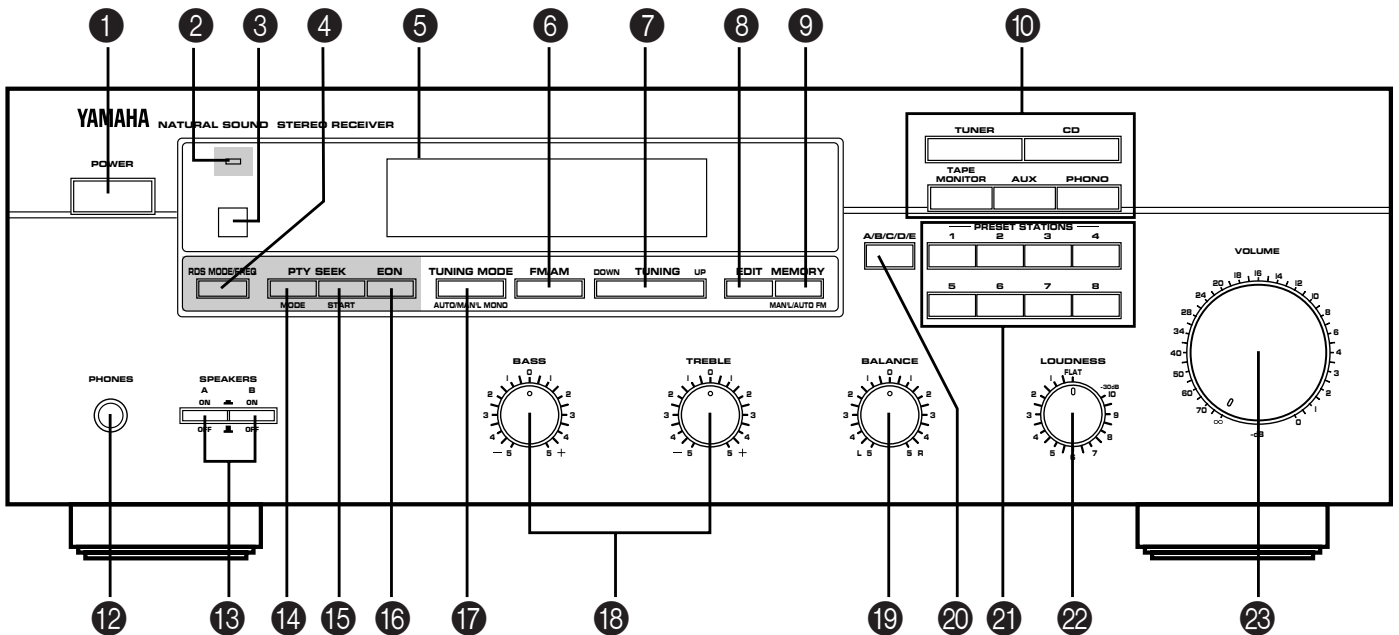

1 POWER switch

Press this switch to switch the power on. Press it again to switch the power off.

* Standby mode

While the power is on, pressing the **POWER** key on the remote control transmitter switches the unit to the standby mode. (In this mode, the power indicator is half illuminated.)

2 Power indicator

Lights up while the power is on.

3 Remote control sensor

Receives signals from the remote control transmitter.

4 RDS MODE/FREQ button

RX-495RDS and RX-395RDS only

When an RDS station is received, pressing this button changes the display mode into the PS mode, PTY mode, RT mode and/or CT mode (if the station employs those RDS data services), and frequency display in turn.

5 Display panel

Shows station frequencies and various information. (Refer to the next page for details.)

6 FM/AM buttons

Press this button to switch the reception band to FM or AM.

7 TUNING DOWN/UP button

Used for tuning. Press the "UP" side to tune in to higher frequencies, and press the "DOWN" side to tune in to lower frequencies.

8 EDIT button

This button is used to exchange the places of two preset stations with each other.

9 MEMORY (MAN'L/AUTO FM) button

When this button is pressed, the MEMO(RY) indicator flashes for about 5 seconds. During this period, press the desired **PRESET STATIONS** button to enter the displayed station into the memory.

When this button is pressed and held for about 3 seconds, the automatic preset tuning begins.

10 Input selector buttons

Select a program source to listen to. When a button is pressed, the name of selected source lights up on the display.

11 PURE DIRECT switch

RX-495RDS only

Press this switch to listen to a source in the purest sound. (Refer to page 16 for details.)

12 PHONES jack

When you listen with headphones, connect the headphones to the **PHONES** jack. When listening with headphones privately, set both the **SPEAKERS A** and **B** switches to the **OFF** position.

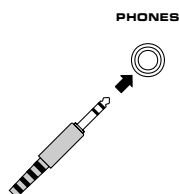
**13 SPEAKERS switches**

Set the switch **A** or **B** (or both **A** and **B**) for the speaker system (connected to this unit) you will use to the **ON** position. Set the switch for the speaker system you will not use to the **OFF** position.

14 PTY SEEK MODE button

RX-495RDS and RX-395RDS only

When this button is pressed, the unit turns into the PTY SEEK mode.

15 PTY SEEK START button

RX-495RDS and RX-395RDS only

Press this button to begin searching for a station after the desired program type is selected in the PTY SEEK mode.

16 EON button

RX-495RDS and RX-395RDS only

Press this button to select a desired program type (NEWS, INFO, AFFAIRS, SPORT) when you want to call a radio program of that program type automatically.

17 TUNING MODE (AUTO/MAN'L) button

Press this button to switch the tuning mode to automatic or manual. To select the automatic tuning mode, press this button so that "AUTO (TUNING)" lights up on the display. To select the manual tuning mode, press this button so that "AUTO (TUNING)" goes off.

18 Tone controls**BASS**

Used to increase or decrease the low frequency response. The 0 position produces flat response.

TREBLE

Used to increase or decrease the high frequency response. The 0 position produces flat response.

19 BALANCE control

Adjusts the balance of the output volume to the left and right speakers to compensate for sound imbalance caused by speaker location or listening room conditions.

20 A/B/C/D/E button

Press this button to select a desired group (A–E) of preset stations.

21 PRESET STATIONS buttons

Used to enter as many as 40 station frequencies into the memory.

22 Continuously variable LOUDNESS control

Used to compensate for the human ears' loss of sensitivity to high and low-frequency ranges at low volume.

23 VOLUME control

Used to raise or lower the volume level.

DISPLAY PANEL

RX-495RDS, RX-395RDS

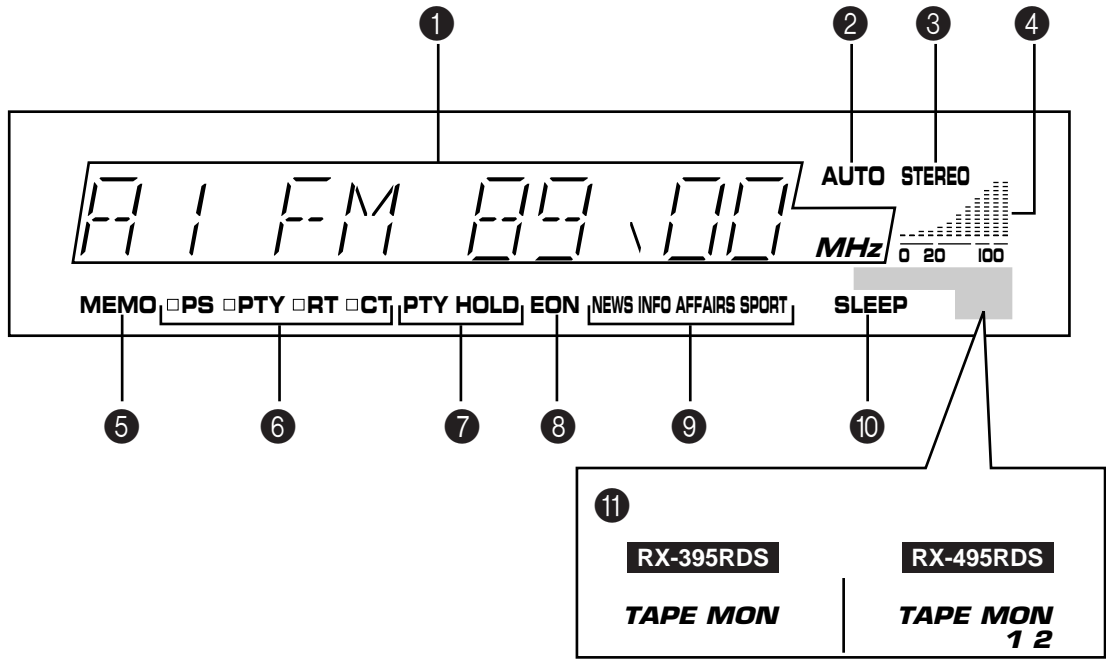

RX-395

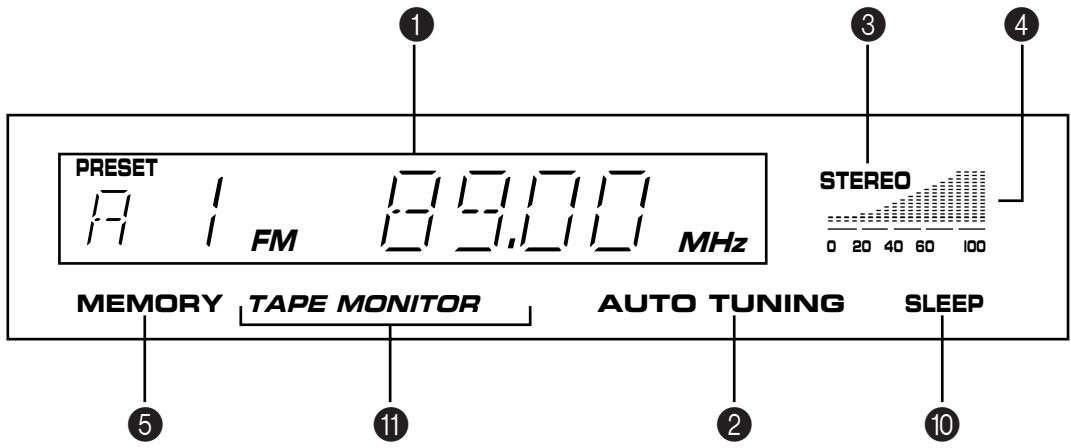

1 Multi-information display

Displays various information, for example station frequency, preset station number and name of selected program source.

2 AUTO (AUTO TUNING) indicator

This indicator lights up when this unit is in the automatic tuning mode.

3 STEREO indicator

Lights up when an FM stereo broadcast with sufficient signal strength is received.

4 Signal-level meter

Indicates the signal level of the received station. If multipath interference is detected, the indication decreases.

5 MEMO (MEMORY) indicator

When the **MEMORY** button is pressed, this indicator flashes for about 5 seconds. During this period, the displayed station can be programmed to the memory by using the **A/B/C/D/E** button and one of the **PRESET STATIONS** buttons.

6 RDS mode indicators**RX-495RDS and RX-395RDS only**

The name(s) of RDS mode(s) employed by the currently received RDS station light(s) up. Illumination of the indicator on the head of a name shows that the corresponding RDS mode is now selected.

7 PTY HOLD indicator**RX-495RDS and RX-395RDS only**

Lights up while the search is performed in the PTY SEEK mode.

8 EON indicator**RX-495RDS and RX-395RDS only**

Lights up when an RDS station that employs the EON data service is received.

9 Program type name indicators**RX-495RDS and RX-395RDS only**

The name selected in the EON mode lights up.

10 SLEEP indicator

Lights up while the built-in SLEEP timer is functioning.

11 TAPE MON (TAPE MONITOR) indicator**RX-395, RX-395RDS**

Lights up when the tape deck is selected as the input source by pressing the **TAPE MONITOR** button.

RX-495RDS

When the first tape deck is selected as the input source by pressing the **TAPE 1** button, "TAPE MON 1" lights up, and when the second tape deck is selected by pressing the **TAPE 2** button, "TAPE MON 2" lights up.

CONNECTIONS

Before attempting to make any connections to or from this unit, be sure to first switch OFF the power to this unit and to any other components to which connections are being made.

CONNECTIONS WITH OTHER COMPONENTS

When making connections between this unit and other components, be sure all connections are made correctly, that is to say L (left) to L, R (right) to R, “+” to “+” and “-” to “-”. Also, refer to the owner’s manual for each component to be connected to this unit.

- * If you have YAMAHA components numbered as 1, 2, 3, etc. on the rear panel, connections can be made easily by making sure to connect the output (or input) terminals of each component to the same-numbered terminals of this unit.

RX-495RDS

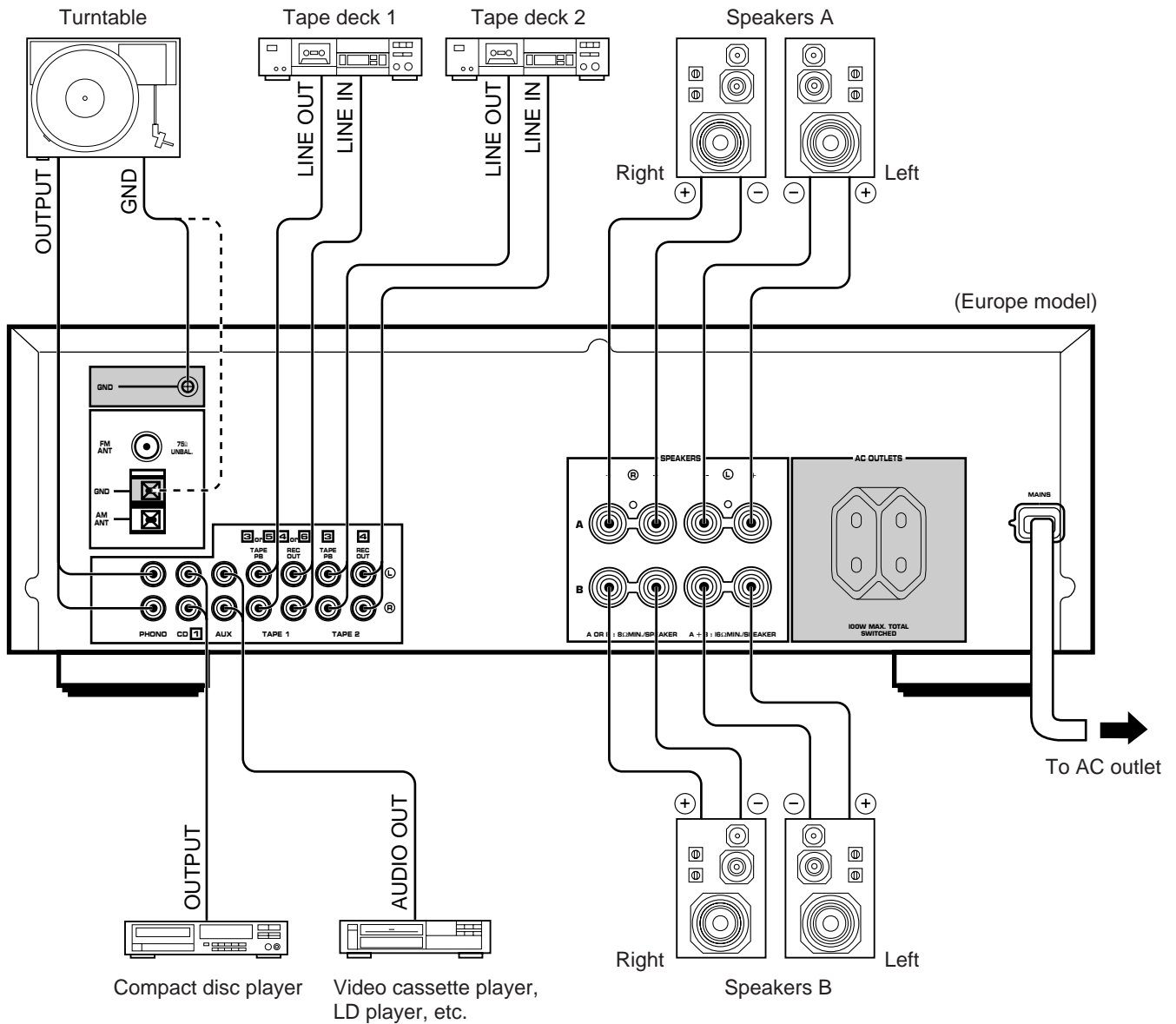

 : Refer to “ABOUT THE ACCESSORY TERMINALS” on page 12.

RX-395, RX-395RDS

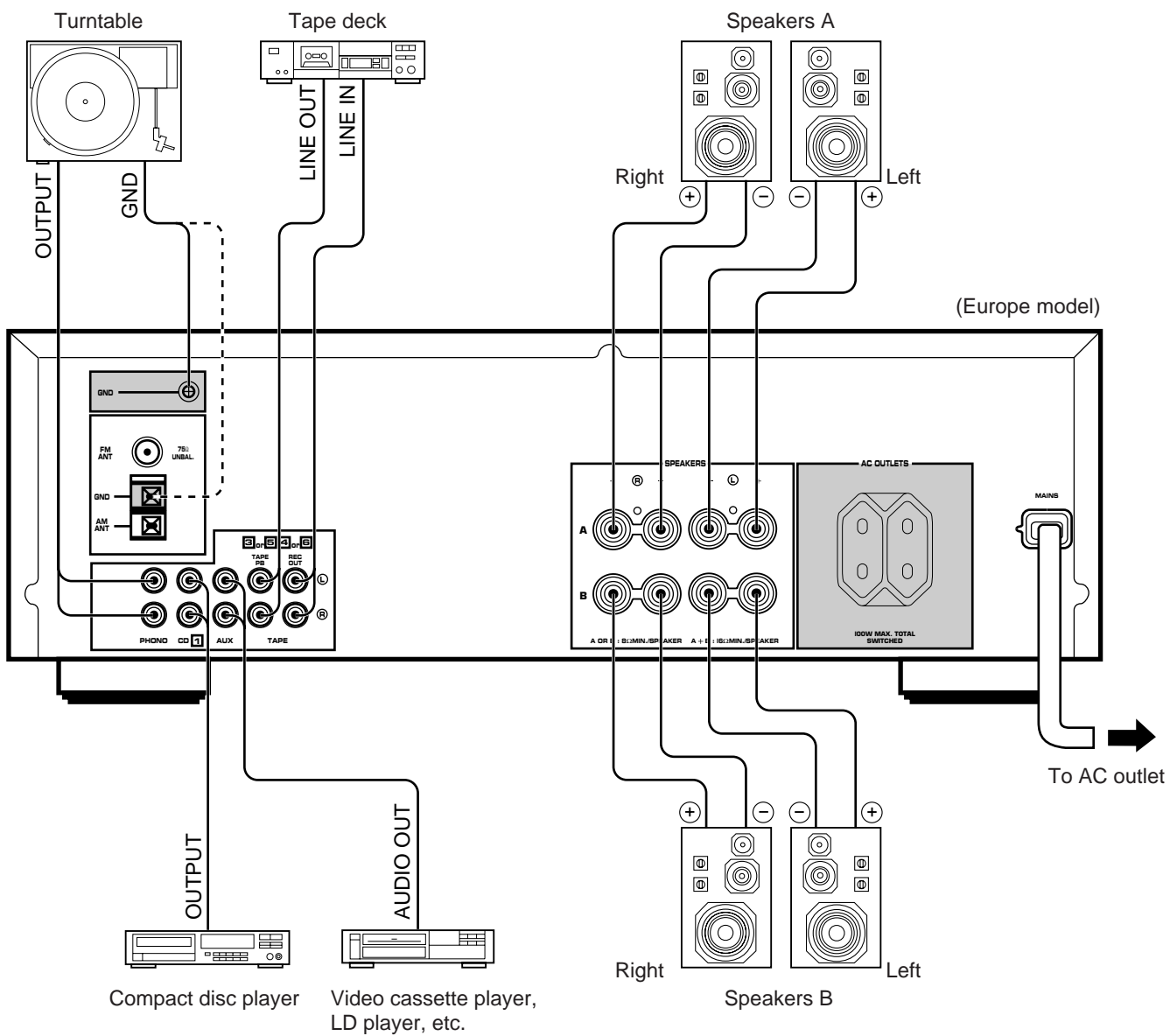

 : Refer to "ABOUT THE ACCESSORY TERMINALS" on page 12.

CONNECTING SPEAKERS

Connect the **SPEAKERS** terminals to your speakers with wire of the proper gauge, cut as short as possible. If the connections are faulty, no sound will be heard from the speakers. Make sure that the polarity of the speaker wires is correct, that is, + and – markings are observed. If these wires are reversed, the sound will be unnatural and will lack bass. **Do not let the bare speaker wires touch each other and do not let them touch the metal parts of this unit as this could damage this unit and/or speakers.**

How to Connect:

Red: positive (+)
Black: negative (–)

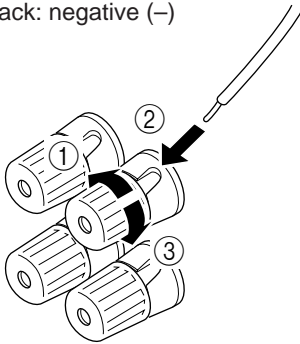

- ① Unscrew the knob.
- ② Insert the bare wire.
[Remove approx. 5mm (1/4") insulation from the speaker wires.]
- ③ Tighten the knob and secure the wire.

Notes

- One or two speaker systems can be connected to this unit. If you connect only one speaker system, connect it to either the **SPEAKERS A** or **B** terminals.
- Use speakers with the specified impedance shown on the rear of this unit.

ABOUT THE ACCESSORY TERMINALS

AC OUTLET(S) (SWITCHED)

(Europe and Singapore models) 2 SWITCHED OUTLETS
(U.K. model) 1 SWITCHED OUTLET
Use these to connect the power cords from your components to this unit.

The power to the **SWITCHED** outlets is controlled by this unit's **POWER** switch or the provided remote control transmitter's **POWER** key. These outlets will supply power to any component whenever this unit is turned on.

The maximum power (total power consumption of components) that can be connected to the **SWITCHED AC OUTLET(S)** is 100 watts.

GND terminal (For turntable use)

Connecting the ground wire of the turntable to the **GND** terminal will normally minimize hum, but in some cases better results may be obtained with the ground wire disconnected. Use one of the two **GND** terminals on the rear of this unit for the connection.

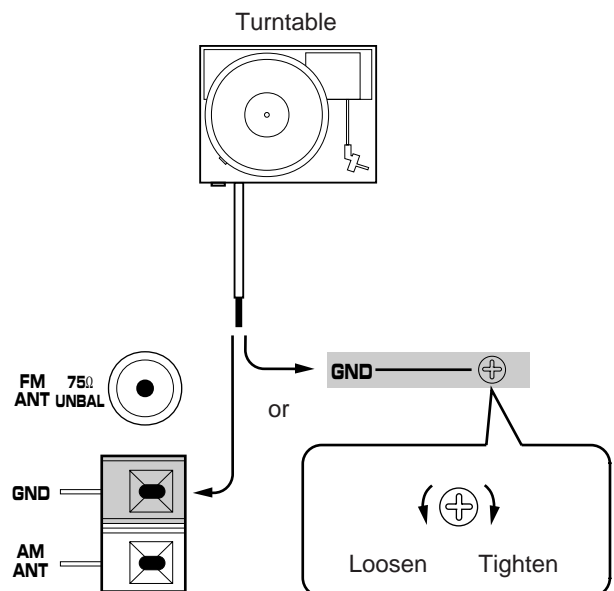

ANTENNA CONNECTIONS

- Each antenna should be connected to the designated terminals correctly, referring to the following diagram.
- Both AM and FM indoor antennas are included with this unit. In general, these antennas will probably provide sufficient signal strength. Nevertheless, a properly installed outdoor antenna will give clearer reception than an indoor one. If you experience poor reception quality, an outdoor antenna may result in improvement.

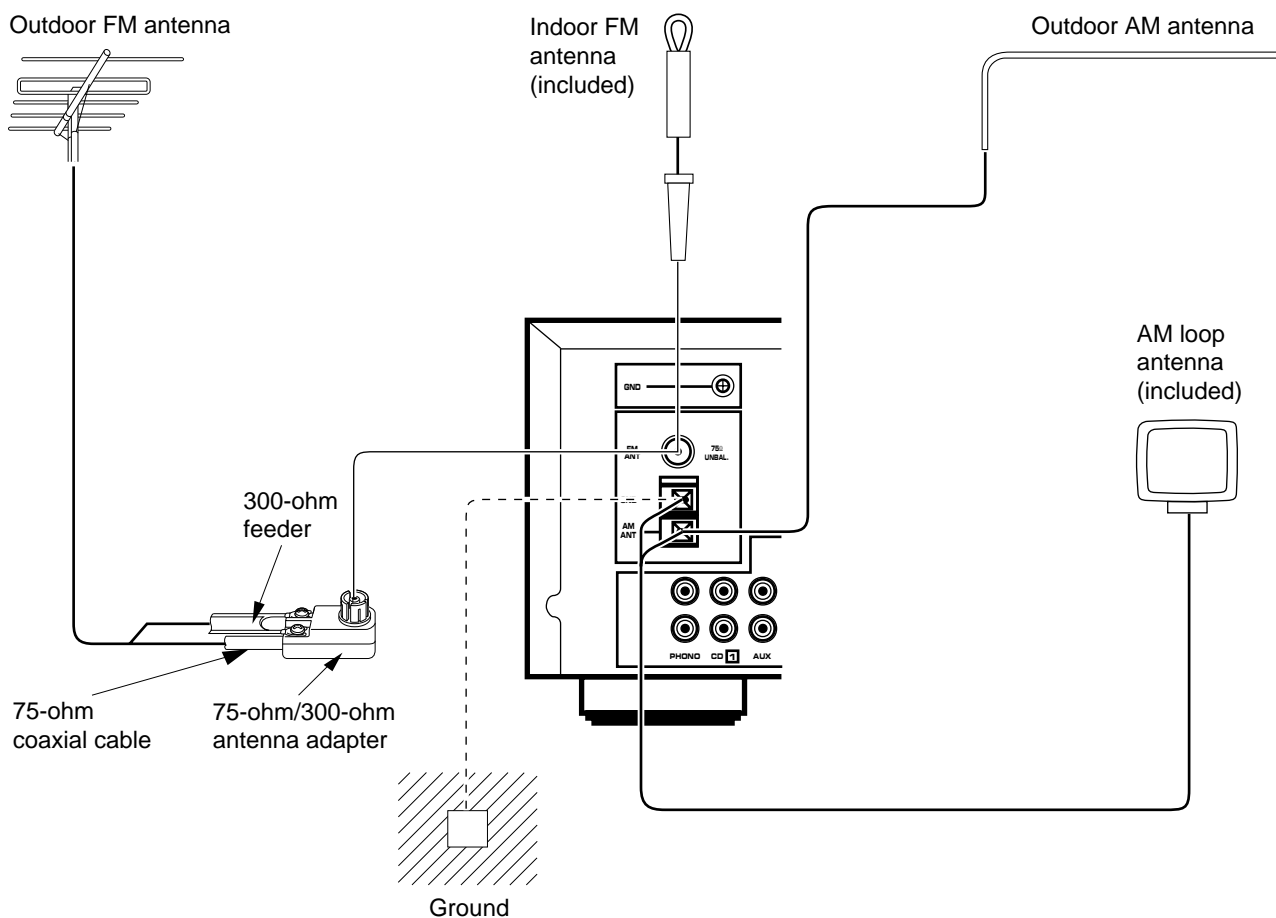

Connecting the AM loop antenna

1

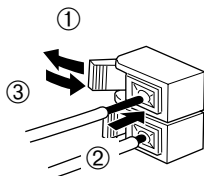

2

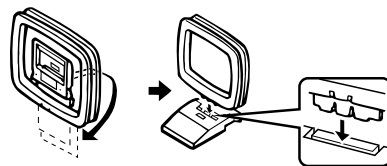

3



Orient so that the best reception is obtained.

* The AM loop antenna should be placed apart from the main unit. The antenna may be hung on a wall.

* The AM loop antenna should be kept connected, even if an outdoor AM antenna is connected to this unit.

GND terminal

For maximum safety and minimum interference, connect the **GND** terminal to a good earth ground. A good earth ground is a metal stake driven into moist earth.

Notes

- When connecting the indoor FM antenna, insert its connector into the **FM ANT** terminal firmly.
- If you need an outdoor FM antenna to improve FM reception quality, either 300-ohm feeder or coaxial cable may be used. In locations troubled by electrical interference, coaxial cable is preferable.

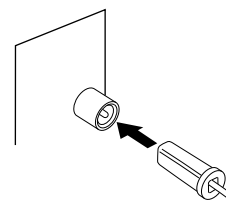

BASIC OPERATIONS

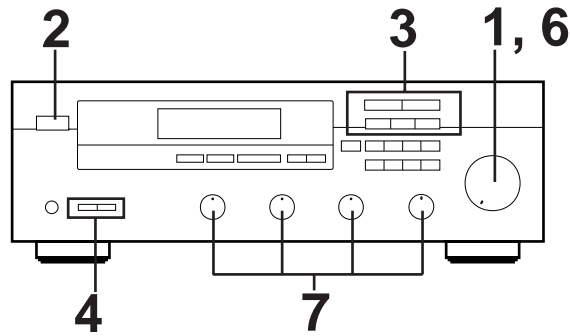

TO PLAY A SOURCE

1

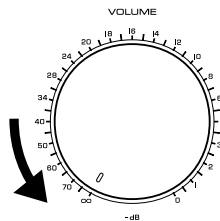

Set to the "∞" position.

2 Turn the power on.

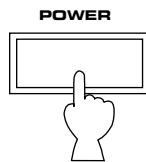

3 Select the desired input source by using the input selector buttons.

RX-495RDS

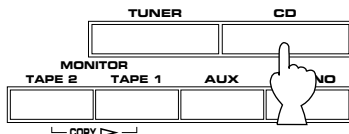

RX-395, RX-395RDS

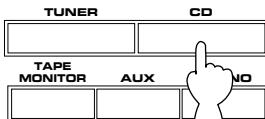

- * The name of the selected input source will appear on the display.
- * Note that pressing on each input selector button selects the source which is connected to the corresponding input terminals on the rear panel.

4 Select the speakers to be used.

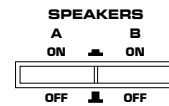

- * If you use two speaker systems, press both the A and B switches.

5 Play the source. (For detailed information on the tuning operation, refer to page 17.)

6

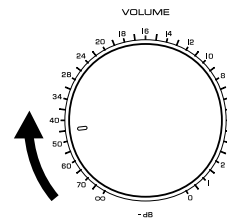

Adjust to the desired output level.

7 If desired, adjust the **BASS, TREBLE, BALANCE** and **LOUDNESS** controls, etc. (refer to page 16).

Notes

RX-495RDS only

- If you select **AUX, TUNER, CD** or **PHONO**, be sure that **TAPE 1** and/or **TAPE 2** are not being selected.
- If you select **TAPE 1** and **TAPE 2** at the same time, the result will be the sound from the tape deck 1.
- For **TAPE 1** and **TAPE 2**, whenever the button is pressed, the corresponding input source is selected or canceled alternately.

RX-395 and RX-395RDS only

- Whenever the **TAPE MONITOR** is pressed, the tape deck is selected or canceled alternately.
- If both **TAPE MONITOR** and another input selector button are selected, **TAPE MONITOR** takes priority of another input selector button.

To turn off the power

Press the **POWER** switch again.

TO RECORD A SOURCE TO TAPE

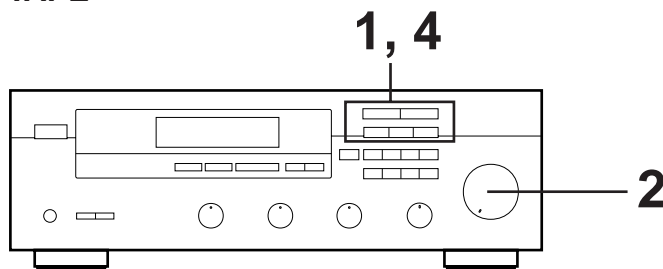

RX-495RDS

1 Select the source to be recorded.

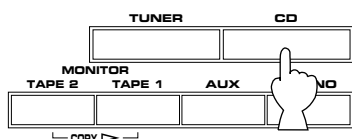

- * To dub from tape to tape, refer to the “Notes” shown below.
- * When you select **AUX, TUNER, CD** or **PHONO**, make sure that neither **TAPE 1** nor **TAPE 2** is also selected.

2 Play the source and then turn the **VOLUME** control up to confirm the input source. (For detailed information on the tuning operations, refer to the page 17.)

3 Begin recording on the tape deck.

4 To monitor the audio signals being recorded, press the input selector button for the tape deck being used to make the recording.

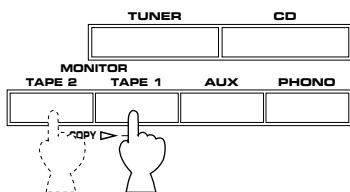

RX-395, RX-395RDS

1 Select the source to be recorded.

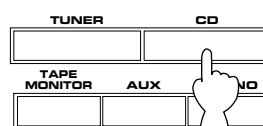

- * When you select **AUX, TUNER, CD** or **PHONO**, make sure that **TAPE MONITOR** is not also selected.

2 Play the source and then turn the **VOLUME** control up to confirm the input source. (For detailed information on the tuning operations, refer to the page 17.)

3 Begin recording on the tape deck.

4 To monitor the audio signals being recorded, press the **TAPE MONITOR**.

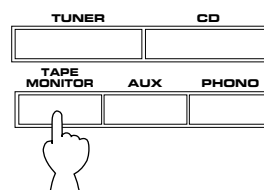

Note
VOLUME, BASS, TREBLE, BALANCE and **LOUDNESS** control settings have no effect on the material being recorded.

Notes

- **VOLUME, BASS, TREBLE, BALANCE, LOUDNESS** controls and **PURE DIRECT** switch settings have no effect on the material being recorded.
- To dub from tape to tape, select **TAPE 2** by pressing it. Only the following method of dubbing can be made by using this unit.

SOURCE	RECORDER
Tape deck connected to the TAPE 2 terminals.	→ Tape deck connected to the TAPE 1 terminals.

Selecting the SPEAKER system

Because one or two speaker systems can be connected to this unit, the **SPEAKERS** switches allow you to select speaker system **A** or **B**, or both at once.

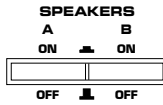

Adjusting the BALANCE control

Adjust the balance of the output volume to the left and right speakers to compensate for sound imbalance caused by speaker location or listening room conditions.



Adjusting the BASS and TREBLE controls

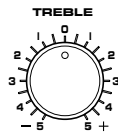

BASS : Turn this clockwise to increase (or counter-clockwise to decrease) the low frequency response.

TREBLE : Turn this clockwise to increase (or counter-clockwise to decrease) the high frequency response.

Using the PURE DIRECT switch

RX-495RDS only

You can enjoy the purest possible sound from your audio sources by pressing this switch inward. By doing so, the audio signal bypasses the **BASS**, **TREBLE**, **BALANCE** and **LOUDNESS** controls, eliminating any alterations to the audio signal.

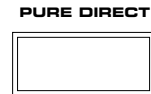

Adjusting the continuously variable LOUDNESS control

This control provides compensation for the human ears' loss of sensitivity to high and low-frequency ranges at low volume. This control is adjustable to retain full tonal range at any volume level.

1

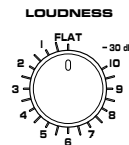

Set to the "FLAT" position.

2

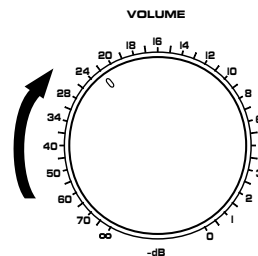

Set to the loudest listening level that you would listen to.

3

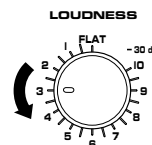

Turn until the desired volume is gained.

TUNING OPERATIONS

Normally, if station signals are strong and there is no interference, quick automatic-search tuning (AUTOMATIC TUNING) is possible. However, if signals of the station you want to select are weak, you must tune to it manually (MANUAL TUNING).

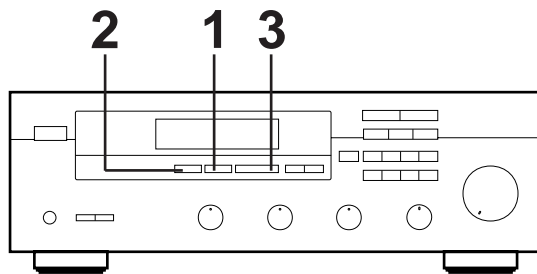

AUTOMATIC TUNING

1 Select the reception band (FM or AM) confirming it on the display.

2

3

To tune to a higher frequency, press the right side once.
To tune to a lower frequency, press the left side once.

- * If the station where tuning search stops is not the desired one, press again.
- * If the tuning search does not stop at the desired station (because the signals of the station are weak), change to the MANUAL TUNING method.

MANUAL TUNING

1 Select the reception band (FM or AM) confirming it on the display.

2

3 Tune to a desired station manually.

* To continue tuning search, press and hold the button.

Notes

- If you tune to an FM station manually, it is received in monaural mode automatically to increase the signal quality.
- **RX-495RDS and RX-395RDS only**

When tuned in to a station, the frequency of the received station is shown on the display. If an RDS station that employs PS data service is received, the frequency is then replaced by the station name. Refer to page 24 for details.

PRESET TUNING

MANUAL PRESET TUNING

This unit can store station frequencies (selected by tuning operation) by using the **PRESET STATIONS** buttons. With this function, you can recall any desired station by only pressing the corresponding **PRESET STATIONS** button. Up to 40 stations (8 stations x 5 groups) can be stored.

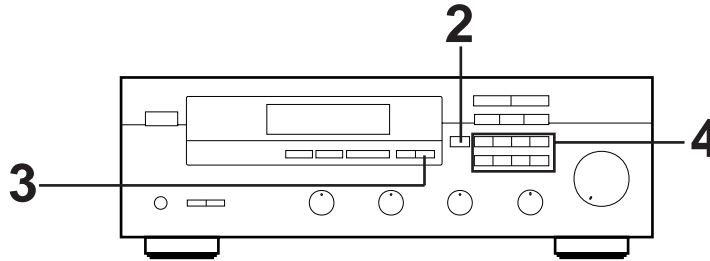

To store stations

1 Tune to a desired station.
(Refer to the previous page for tuning procedure.)

2 Select a desired group (A – E) of preset stations confirming it on the display.

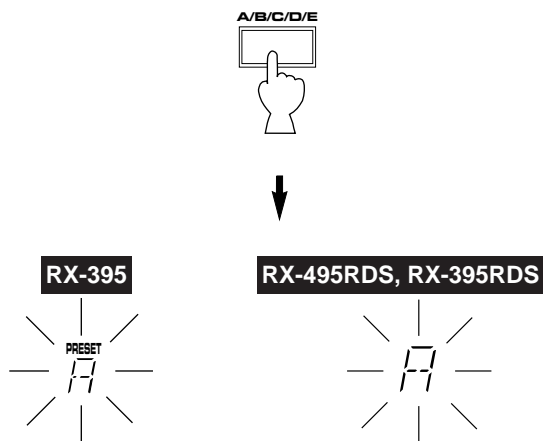

3

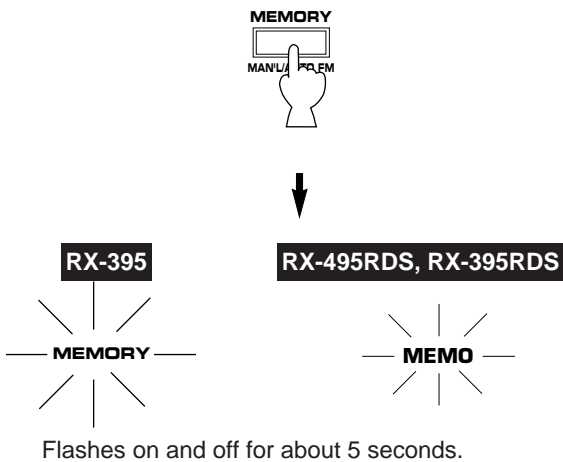

4 Select a preset station number where you want to program the station before "MEMO(RY)" goes off from the display.

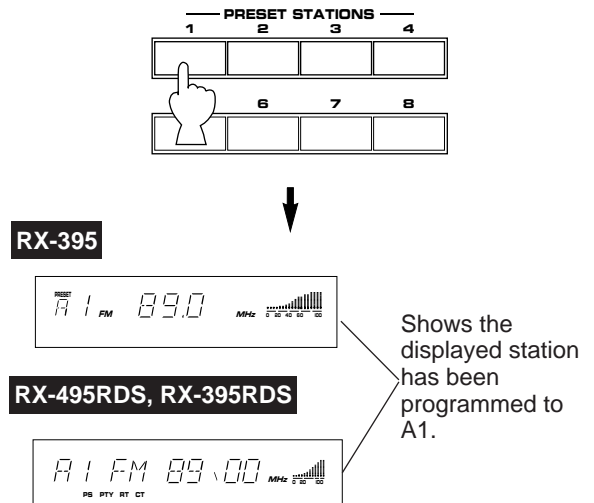

- * In the same way, program other stations to A2, A3 ... A8.
- * You can program more stations to preset station numbers on other groups in the same way by selecting other groups in step 2.

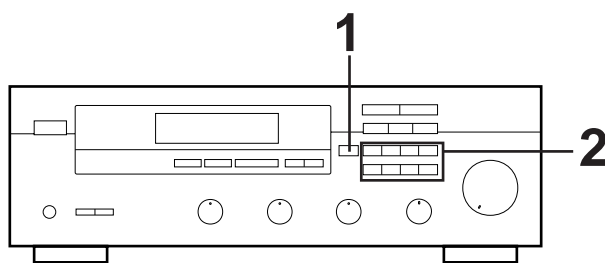

To recall a preset station

- 1** Select the group of preset stations.

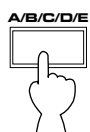

RX-395

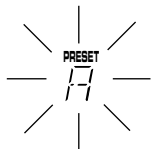

RX-495RDS, RX-395RDS

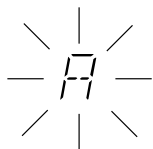

Notes

- A new setting can be programmed in place of the former one.
- For presets, the setting of the reception mode (stereo or monaural) is stored along with the station frequency.

Memory back-up

The memory back-up circuit prevents the programmed data from being lost even if the **POWER** switch is set off or the power plug is disconnected from the AC outlet or the power is cut due to temporary power failure. If, however, the power is cut for more than one week, the memory may be erased. If so, it can be re-programmed by simply following the PRESET TUNING steps.

- 2** Select the preset station number.

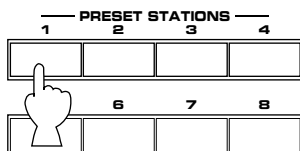

RX-395



RX-495RDS, RX-395RDS

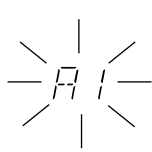

AUTOMATIC PRESET TUNING

You can also make use of an automatic preset tuning function for FM stations only. By this function, this unit performs automatic tuning and stores FM stations with strong signals sequentially. Up to 40 stations are stored automatically in the same way as in the manual preset tuning method on page 18.

*** RX-495RDS and RX-395RDS only**

Only RDS stations can be stored by this function.

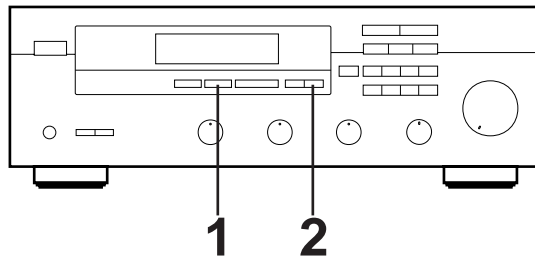

To store stations

1 →

2 Press and hold for about 3 seconds.

RX-395

Flashes.

RX-495RDS, RX-395RDS

Flashes.

The automatic preset tuning begins from A1. Received stations are programmed to A1, A2 ... A8 sequentially.
 * If more than 8 stations are received, they are also programmed to the preset station numbers on other groups (B, C, D and E) in that order.

RX-395 only

If you want to store the first station received by the automatic preset tuning to a desired preset station number.

If, for example, you want to store the first received station to C5, select "C5" by using the **A/B/C/D/E** button and the **PRESET STATIONS** buttons after pressing the **MEMORY** button in step 2 before the automatic preset tuning begins. The first received station is stored to C5, and next stations to C6, C7 ... sequentially.

If stations are stored up to E8, the automatic preset tuning is finished automatically.

When the automatic preset tuning is finished

The display shows the frequency of the last preset station. Check the contents and the number of preset stations by following the procedure of the section "To recall a preset station" on page 19.

To recall a preset station

Simply follow the procedure of the section "To recall a preset station" on page 19.

*** RX-495RDS and RX-395RDS only**

A recalled station is shown by the frequency or station name on the display.

Notes

- If no station is received by the automatic preset tuning search, the search finishes after "NOTHING" flashes for about 3 seconds on the display.
- You can replace a preset station by another FM or AM station manually by simply following the procedure of the section "To store stations" on page 18.

RX-395 only

- If the number of received stations is not enough to be stored up to E8, the search will be finished automatically when it reaches the highest frequency after searching through all frequencies.
- With this function, only FM stations with sufficient signal strength are stored automatically. If the station you want to program is weak in signal strength, tune to it in monaural manually and program it by following the procedure of the section "To store stations" on page 18.

RX-495RDS and RX-395RDS only

- The automatic preset tuning search is performed through all RDS network frequencies until stations are stored up to E8. If the number of received stations is not enough to be stored up to E8, the search will be finished automatically after searching all frequencies.
- With this function, only RDS stations with sufficient signal strength are stored automatically. If the station you want to program is weak in signal strength, tune to it in monaural manually and program it by following the procedure of the section "To store stations" on page 18.

* There may be a case that this function cannot receive a station which could be received by the automatic tuning method. This is because this function receives a large volume of PI (Program Identification) data along with the station.

EXCHANGING PRESET STATIONS

You can exchange the places of two preset stations with each other as shown below.

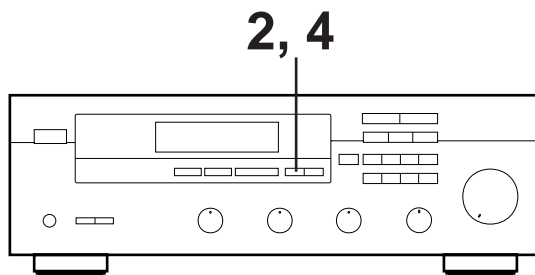

Example)

If you want to shift the preset station on E1 to A5, and vice versa.

1 Recall the preset station on E1 (by following the method of "To recall a preset station" on page 19).

2

RX-395 **RX-495RDS, RX-395RDS**

Flashes. Flashes.

4

RX-395 **RX-495RDS, RX-395RDS**

Flashes. Flashes.

Shows the exchange of stations is completed.

3 Next, recall the preset station on A5 by following the same method with step 1.

RX-395 **RX-495RDS, RX-395RDS**

Flashes. Flashes.

In areas where RDS broadcasts cannot be received, the RDS broadcast functions do not operate. (The procedures from page 22 to page 26 are not necessary.)

RECEIVING RDS STATIONS

***RX-495RDS* and *RX-395RDS* only**

RDS (Radio Data System) is a data transmission system gradually being introduced by FM stations in many countries. Stations using this system transmit an inaudible stream of data in addition to the normal radio signal.

RDS data contains various information, such as PI (Program Identification), PS (Program Service name), PTY (Program Type), RT (Radio Text), CT (Clock Time), EON (Enhanced Other Networks), etc.

RDS function is carried out among the network stations.

* This unit utilizes PI, PS, PTY, RT, CT and EON to receive RDS broadcast stations.

Displaying RDS data

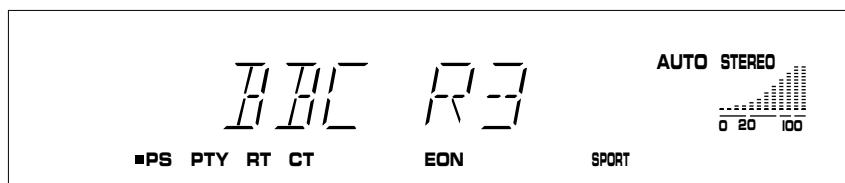

This unit can be turned into the following five modes to display RDS data.

PS (Program Service name) mode:

Displays the name of the RDS station now being received instead of the frequency.

PTY (Program Type) mode:

Displays the type of the program on the RDS station now being received. There are 15 program types to classify RDS stations. Refer to the next page for details.

RT (Radio Text) mode:

Displays information about the program (such as title of the song, name of the singer, etc.) on the RDS station now being received.

CT (Clock Time) mode:

Displays current time. This signal comes from the RDS station now being received.

EON (Enhanced Other Networks) mode:

Automatically receives a program of the designated program type when its broadcast starts, in place of the program now being received. When the broadcast of the called program ends, the previously received program (or another program on the same station) is recalled.

Programs types in the PTY mode

- NEWS** **News:**
Short accounts of facts, events and publicly expressed views, reportage and actuality.
- AFFAIRS** **Current affairs:**
Topical program expanding or enlarging upon the news, generally in different presentation style or concept, including documentary debate, or analysis.
- INFO** **Information:**
Program whose purpose is to impart advice in the widest sense, including meteorological reports and forecasts, consumer affairs, medical help, etc.
- SPORT** **Sport:**
Program concerned with any aspect of sport.
- EDUCATE** **Education:**
Program intended primarily to educate, of which the formal element is fundamental.
- DRAMA** **Drama:**
All radio plays and serials.
- CULTURE** **Culture:**
Programs concerned with any aspect of national or regional culture, including religious affairs, philosophy, social science, language, theatre, etc.
- SCIENCE** **Science:**
Programs about the natural sciences and technology.
- VARIED** **Varied:**
Used for mainly speech-based programs usually of light-entertainment nature, not covered by above categories. Examples are: quizzes, panel games, personality interviews, comedy and satire.
- POP M** **Pop:**
Commercial music, which would generally be considered to be of current popular appeal, often featuring in current or recent record sales charts.
- ROCK M** **Rock:**
Contemporary modern music, usually written and performed by young musicians.
- M.O.R. M** **M.O.R.:**
(Middle of the Road Music). Common term to describe music considered to be “easy-listening”, as opposed to Pop, Rock or Classical. Music in this category is often but not always, vocal, and usually of short duration (<5 min.)
- LIGHT M** **Light classics:**
Classical Musical for general, rather than specialist appreciation. Examples of music in this category are instrumental music, and vocal or choral works.
- CLASSICS** **Serious classics:**
Performances of major orchestral works, symphonies, chamber music etc., and including Grand Opera.
- OTHER M** **Other music:**
Musical styles not fitting into any of the above categories. Particularly used for specialist music, of which Jazz, Rhythm & Blues, Folk, Country, and Reggae are examples.

Changing the RDS modes

When an RDS station is received, "PS", "PTY", "RT" and/or "CT" that correspond to the RDS data services employed by the station light up on the display. By pressing the **RDS MODE/FREQ** button once or more, you can change the display mode among the RDS modes employed by the received station in the order shown below. (The RDS mode not employed by the station cannot be selected.) Illumination of the indicator on the head of a name of RDS mode shows that the corresponding RDS mode is now selected.

* When an RDS station is received, do not press the **RDS MODE/FREQ** button until one or some names of RDS modes light up on the display. If the button is pressed before one or some names light up on the display, the mode cannot be changed. This is because the unit has not received all of the RDS data on the station yet.

* If no name of RDS mode lights up on the display, the mode cannot be changed.

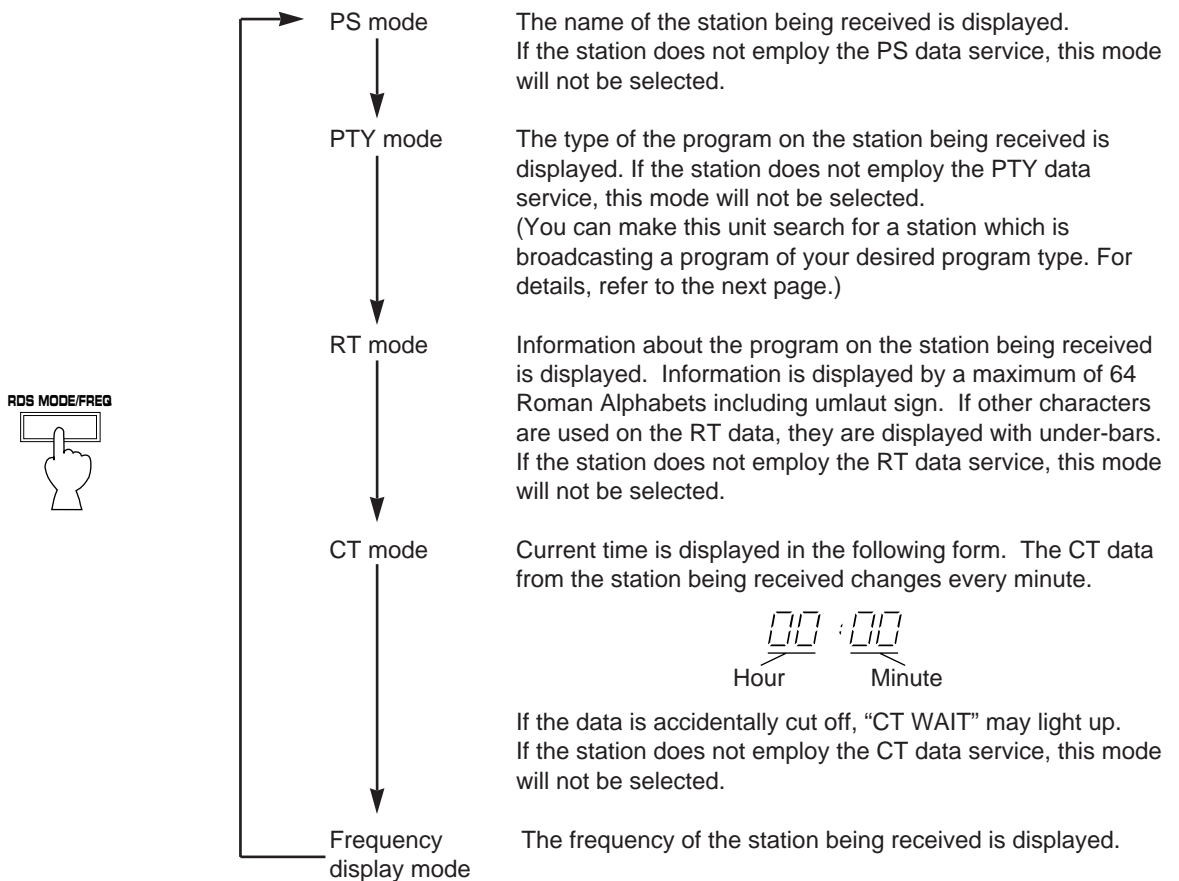

Notes

- RDS data service cannot be utilized by this unit if the received signal is not strong enough. Especially, the RT (Radio Text mode) needs much data to be received, so it may occur that RT mode cannot be displayed even if other RDS modes (PS, PTY, etc.) are displayed.
- There may be a case that RDS data reception is not possible due to poor reception conditions. If so, press the **TUNING MODE** button so that "AUTO (AUTO TUNING)" goes off from the display. Though the reception mode is changed to monaural by this operation, when you change the display to an RDS mode, RDS data may be displayed.
- If the signal strength gets weakened by external interference during receiving an RDS station, the RDS data service may be cut off suddenly and "... WAIT" will light up on the display.

Calling a program of your desired program type from among preset RDS stations (PTY SEEK)

By designating a program type, the unit automatically searches all preset stations for an RDS station which broadcasts a program of that program type.

* There are 15 program types to classify RDS stations. For details, refer to page 23.

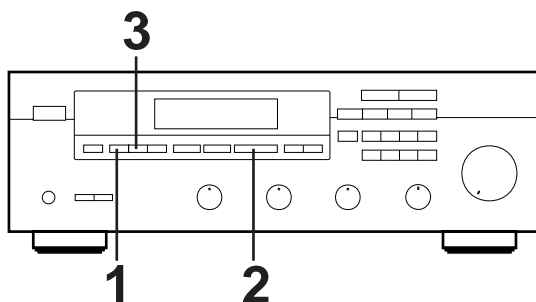

1 Turn the unit into the PTY SEEK mode.

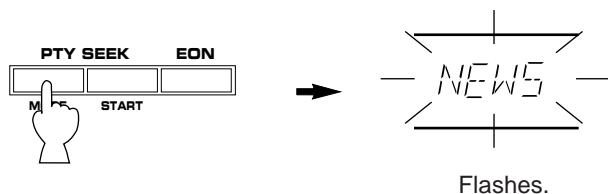

* The program type of the station now being received or "NEWS" flashes on the display.

2 Select the desired program type.

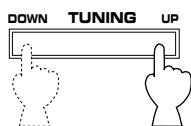

3 Begin searching all preset RDS stations.

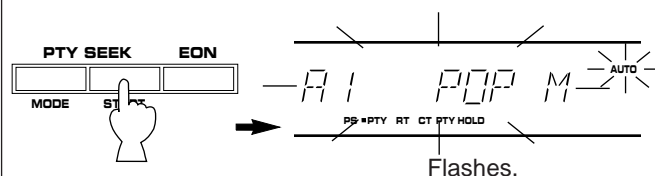

* "PTY HOLD" lights up on the display.

- If a station which broadcasts a program of the program type is found, the unit stops at the station and displays the frequency of the station. If the station has PS data, after that, it turns into the PS mode.
- If the called station is not the desired one, press the **PTY SEEK START** button once more. The unit begins searching for another station which broadcasts a program of the same program type.
- If no station is found, "NOTHING" appears and then returns to frequency display. If the station has PS data, after that, it turns into the PS mode.
 - * If the **PTY SEEK START** button is pressed once more during searching, this mode is canceled and turns into the frequency display. If the station has PS data, after that, it turns into the PS mode.

To cancel this function

If the **PTY SEEK MODE** button is pressed once more, the PTY SEEK mode is canceled and turns into the frequency display. If the station has PS data, after that, it turns into the PS mode.

Making this unit call a program of your desired program type automatically when its broadcast starts

This function uses the EON (Enhanced Other Networks) data service on the RDS station network.

By only selecting a desired program type (NEWS, INFO, AFFAIRS or SPORT), this unit automatically searches all preset RDS stations for a station that broadcasts a program of that program type in the background, and, if found, receives a program when its broadcast starts in place of the program now being received.

* This function can be used only when an RDS station that employs the EON data service is received. (When such a station is received, "EON" lights up on the display.)

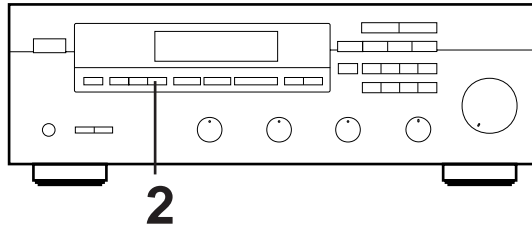

- 1** Make sure that "EON" is illuminated on the display.

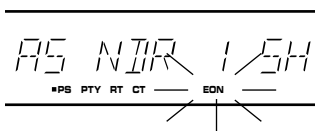

* If "EON" is not illuminated on the display, receive an (or another) RDS station so that "EON" lights up on the display.

- 2** Select a desired program type, NEWS, INFO, AFFAIRS or SPORT.

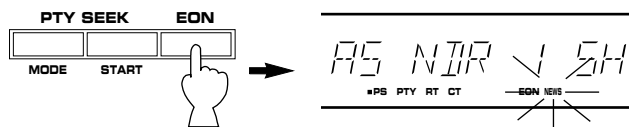

Press once or more.

Lights up.

The search is performed among all preset RDS stations in the background. If a program is found, the program is automatically received when its broadcast starts.

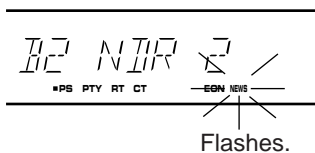

Flashes.

- 3** When the broadcast of the called program ends, the previously received program (or another program on the same station) is recalled.



To cancel this function

Press the **EON** button once or more, so that no program type name lights up on the display.

NOTES ABOUT THE REMOTE CONTROL TRANSMITTER

Battery installation

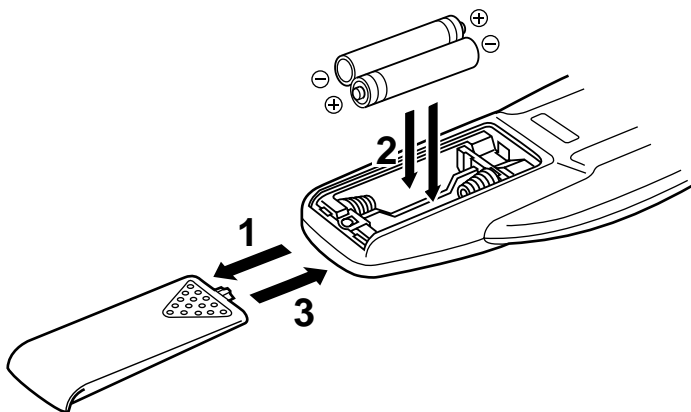

Battery replacement

If you find that the remote control transmitter must be used closer to the main unit, the batteries are weak. Replace both batteries with new ones.

Notes

- Use only AA, R6, UM-3 batteries for replacement.
- Be sure the polarities are correct. (See the illustration inside the battery compartment.)
- Remove the batteries if the remote control transmitter will not be used for an extended period of time.
- If batteries leak, dispose of them immediately. Avoid touching the leaked material or letting it come in contact with clothing, etc. Clean the battery compartment thoroughly before installing new batteries.

Remote control transmitter operation range

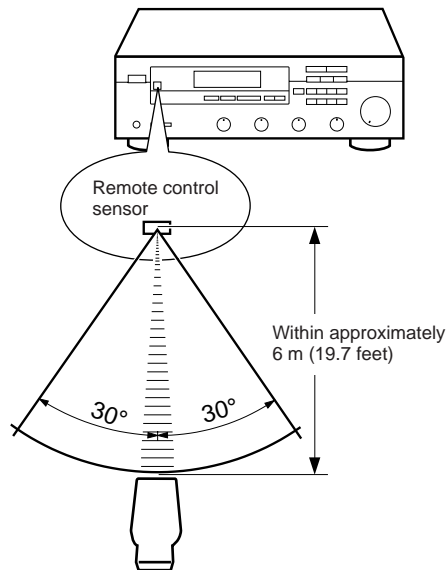

Notes

- There should be no large obstacles between the remote control transmitter and the main unit.
- If the remote control sensor is directly illuminated by strong lighting (especially an inverter type of fluorescent lamp etc.), it might cause the remote control transmitter not to work correctly. In this case, reposition the main unit to avoid direct lighting.

TROUBLESHOOTING

If the unit fails to operate normally, check the following points to determine whether the fault can be corrected by the simple measures suggested. If it cannot be corrected, or if the fault is not listed in the SYMPTOM column, disconnect the power cord and contact your authorized YAMAHA dealer or service center for help.

	SYMPTOM	CAUSE	REMEDY
Amplifier	The unit fails to turn on when the POWER switch is pressed.	Power cord is not plugged in or is not completely inserted.	Firmly plug in the power cord.
	No sound.	Incorrect output cord connections.	Connect the cords properly. If the problem persists, the cords may be defective.
		Appropriate input selector button is not pressed.	Press the appropriate input selector button corresponding to the input source.
		The SPEAKERS switches are not set properly.	Set the SPEAKERS switch that corresponds to the speakers to be used to the ON position.
		Speaker connections are not secure.	Secure the connections.
	The sound suddenly goes off.	The protection circuit has been activated because of short circuit etc.	Turning the unit off and then on will reset the protection circuit.
		The SLEEP timer functioned.	Cancel the SLEEP timer function.
	Only one side speaker outputs the sound.	Incorrect setting of the BALANCE control.	Adjust it to the appropriate position.
		Incorrect cord connections.	Connect the cords properly. If the problem persists, the cords may be defective.
	There is a lack of bass, and no ambience.	The + and – wires are connected in reverse at this unit or speakers.	Connect the speaker wires in the correct phase (+ and –).
	Sound “hums”.	Incorrect cord connections.	Firmly connect the audio plugs. If the problem persists, the cords may be defective.
		No connection from the turntable to the GND terminal.	Make the GND connection between the turntable and this unit.
	Sound level is low.	The LOUDNESS control is functioning.	Set the LOUDNESS control to the FLAT position.
The volume level is low while playing a record.	The record is being played on a turntable with an MC cartridge.	The player should be connected to the unit through an MC head amplifier (available separately).	
The volume level cannot be increased, or sound is distorted.	The power to the component connected to the REC OUT terminals of this unit is off.	Turn the power to the component on.	
FM	FM stereo reception is noisy.	Because of the characteristics of FM stereo broadcasts, this is limited to cases where the transmitter is too far away or the antenna input is poor.	Check the antenna connections. Try using a high quality directional FM antenna. Set the TUNING MODE button to the manual tuning mode.
	There is distortion and clear reception cannot be obtained even with a good FM antenna.	There is multipath interference.	Adjust antenna placement to eliminate multipath interference.
	A desired station cannot be tuned in with the automatic tuning method.	The station is too weak.	Use the manual tuning method. Use a high quality directional FM antenna.
	Previously preset stations can no longer be tuned in.	The tuner has been unplugged for a long period.	Repeat the presetting procedure.
AM	A desired station cannot be tuned in with the automatic tuning method.	Weak signal or loose antenna connections.	Tighten the AM loop antenna connections and rotate it for best reception. Use the manual tuning method.
	There are continuous crackling and hissing noises.	Noises will result from lightning, fluorescent lamps, motors, thermostats and other electrical equipment.	Use an outdoor antenna and a ground wire. This will help somewhat but it is difficult to eliminate all noise.
	There are buzzing and whining noises (especially in the evening).	A television set is being used nearby.	Relocate this unit away from the TV.
Remote control transmitter	The remote control transmitter does not work.	Direct sunlight or lighting (of an inverter type of fluorescent lamp etc.) is striking the remote control sensor of the main unit.	Change the position of the main unit.
		The batteries of this remote control transmitter are too weak.	Replace the batteries with new ones.
Others	The sound is degraded when listening with the headphones connected to the compact disc player or cassette deck that are connected with this unit.	The power to this unit is off.	Turn the power to this unit on.

SPECIFICATIONS

AUDIO SECTION

Minimum RMS Output Power per Channel

8 ohms, 20 Hz to 20 kHz, 0.04% THD
<RX-495RDS>70W+70W
<RX-395, RX-395RDS>45W+45W

Dynamic Power per Channel

(by IHF Dynamic Headroom measuring method)
<RX-495RDS>
8/6/4/2 ohms100/120/145/170W
<RX-395, RX-395RDS>
8/6/4/2 ohms68/75/85/95W

DIN Standard Output Power per Channel

4 ohms, 1 kHz, 0.7% THD
[Europe model only]
<RX-495RDS>100W
<RX-395, RX-395RDS>55W

IEC Power

8 ohms, 1 kHz, 0.04% THD
[Europe model only]
<RX-495RDS>80W
<RX-395, RX-395RDS>50W

Power Band Width

<RX-495RDS>
8 ohms, 35W, 0.08% THD10 Hz to 50 kHz
<RX-395, RX-395RDS>
8 ohms, 22.5W, 0.08% THD10 Hz to 50 kHz

Damping Factor

8 ohms, 20 Hz to 20 kHz100 or more

Input Sensitivity/Impedance

PHONO MM2.5 mV/47 k-ohms
CD/TAPE/AUX150 mV/47 k-ohms

Maximum Input Signal (1 kHz, 0.04% THD)

PHONO MM90 mV

Output Level

REC OUT150 mV

Headphone Jack Rated Output/Impedance

Output Level (8 ohms, 0.04% THD)
<RX-495RDS>0.48V
<RX-395, RX-395RDS>0.45V
Impedance
<RX-495RDS>390 ohms
<RX-395, RX-395RDS>330 ohms

Frequency Response (20 Hz to 20 kHz)

CD/TAPE/AUX0±0.5 dB

RIAA Equalization Deviation

PHONO MM0±0.5 dB

Total Harmonic Distortion

PHONO MM to REC OUT
20 Hz to 20 kHz, 1V0.02%
CD/TAPE/AUX to SP OUT
20 Hz to 20 kHz, 35W/8 ohms0.02%

Signal-to-Noise Ratio (IHF-A Network)

PHONO MM to REC OUT
(5 mV Input Shorted)82 dB
CD/TAPE/AUX to SP OUT (Input Shorted)108 dB

Residual Noise (IHF-A Network)100 µV

Channel Separation (Vol. -30 dB, EFFECT OFF)

CD/TAPE/AUX
(Input 5.1 k-ohms Terminated, 1 kHz)60 dB

Tone Control Characteristics

BASS: Boost/cut±10 dB (50 Hz)
Turnover Frequency(350 Hz)
TREBLE: Boost/cut±10 dB (20 kHz)
Turnover Frequency(3.5 kHz)

Continuous Loudness Control- 30 dB (1 kHz)
(Level related equalization)

FM SECTION

Tuning Range	87.5 to 108.0 MHz
Usable Sensitivity (75 ohms)	
DIN, Mono (S/N 26 dB)	0.9 μ V
DIN, Stereo (S/N 46 dB)	24 μ V
Image Response Ratio	80 dB
IF Response Ratio	80 dB
Spurious Response Ratio	70 dB
AM Suppression Ratio	55 dB
Capture Ratio.....	1.5 dB
Selectivity (two signals, \pm 300 kHz, 40 kHz Dev.)	70 dB
Signal-to-Noise Ratio (DIN-Weighted, 40 kHz Dev.) Mono/Stereo	75 dB/70 dB
Harmonic Distortion Mono/Stereo (1kHz, 40 kHz Dev.)	0.1%/0.2%
Stereo Separation (1 kHz, 40 kHz Dev.).....	50 dB
Frequency Response 20 Hz to 15 kHz	0 \pm 1.5 dB

AM SECTION

Tuning Range	531 to 1,611 kHz
Usable Sensitivity	100 μ V/m
Selectivity.....	32 dB
Signal-to-Noise Ratio	50 dB
Image Response Ratio	40 dB
Spurious Response Ratio	50 dB
Harmonic Distortion (1 kHz).....	0.3%

AUDIO SECTION

Output Level/Impedance FM (1 kHz, 40 kHz Dev.)	500 mV/2.2 k-ohms
AM (30% mod., 1 kHz)	150 mV/2.2 k-ohms

GENERAL

Power Supply	AC 230V, 50 Hz
Power Consumption	
<RX-495RDS>	120W
<RX-395, RX-395RDS>	145W
AC Outlets	
2 SWITCHED OUTLETS [Europe model].....	100W max. total
1 SWITCHED OUTLET [U.K. model]	100W max. total
Dimensions (W x H x D)	435 x 146 x 308.5 mm
Weight	
<RX-495RDS>	7.8 kg
<RX-395, RX-395RDS>	6.5 kg
Accessories.....	AM loop antenna Indoor FM antenna Remote control transmitter Batteries

Specifications are subject to change without notice.

FM GEDEELTE

Afstembereik	87,5 tot 108,0 MHz
Effectieve Gevoeligheid (75 ohm)	
DIN, Mono (Signaal/Ruis 26 dB)	0,9 μ V
DIN, Stereo (Signaal/Ruis 46 dB)	24 μ V
Spiegelfrekwentie Verhouding	80 dB
IF Frekwentiebereik Verhouding	80 dB
Parasitaire Frekwentieverhouding	70 dB
AM Ruisonderdrukkingsverhouding	55 dB
Opvangfrekwentieverhouding	1,5 dB
Selectiviteit (twee signalen, \pm 300 kHz, 40 kHz Afw.)	
.....	70 dB
Signaal/Ruisverhouding	
(DIN-norm, 40 kHz Afw.) Mono/Stereo	75 dB/70 dB
Harmonische Vervorming	
(1 kHz, 40 kHz Afw.) Mono/Stereo	0,1%/0,2%
Stereo Scheiding (1 kHz, 40 kHz Afw.)	50 dB
Frekwentiebereik	
20 Hz tot 15 kHz	0 \pm 1,5 dB

AM GEDEELTE

Afstembereik	531 tot 1.611 kHz
Effectieve Gevoeligheid	100 μ V/m
Selectiviteit	32 dB
Signaal/Ruisverhouding	50 dB
Spiegelfrekwentie Verhouding	40 dB
Parasitaire Frekwentieverhouding	50 dB
Harmonische Vervorming (1 kHz)	0,3%

AUDIO GEDEELTE

Uitgangsniveau/Impedantie	
FM (1 kHz, 40 kHz Afw.)	500 mV/2,2 k-ohm
AM (30% mod., 1 kHz)	150 mV/2,2 k-ohm

ALGEMEEN

Spanningsvereisten230V, 50 Hz wisselstroom

Stroomverbruik

<RX-495RDS>	120W
<RX-395, RX-395RDS>	145W

Netspanningsuitgangen (AC OUTLETS)

2 GESCHAKELDE NETSPANNINGSUITGANGEN

[Modellen voor Europa]

.....Max. totaal vermogen: 100W

1 GESCHAKELDE NETSPANNINGSUITGANG

[Modellen voor Groot-Brittannië]

.....Max. totaal vermogen: 100W

Afmetingen (L x H x B)435 x 146 x 308,5 mm

Gewicht

<RX-495RDS>	7,8 kg
<RX-395, RX-395RDS>	6,5 kg

Toebehoren.....AM Lusantenne
FM Binnenantenne
Afstandbediening
Batterijen

Alle specificaties zijn onder voorbehoud en kunnen zondere nadere kennisgeving worden gewijzigd.